

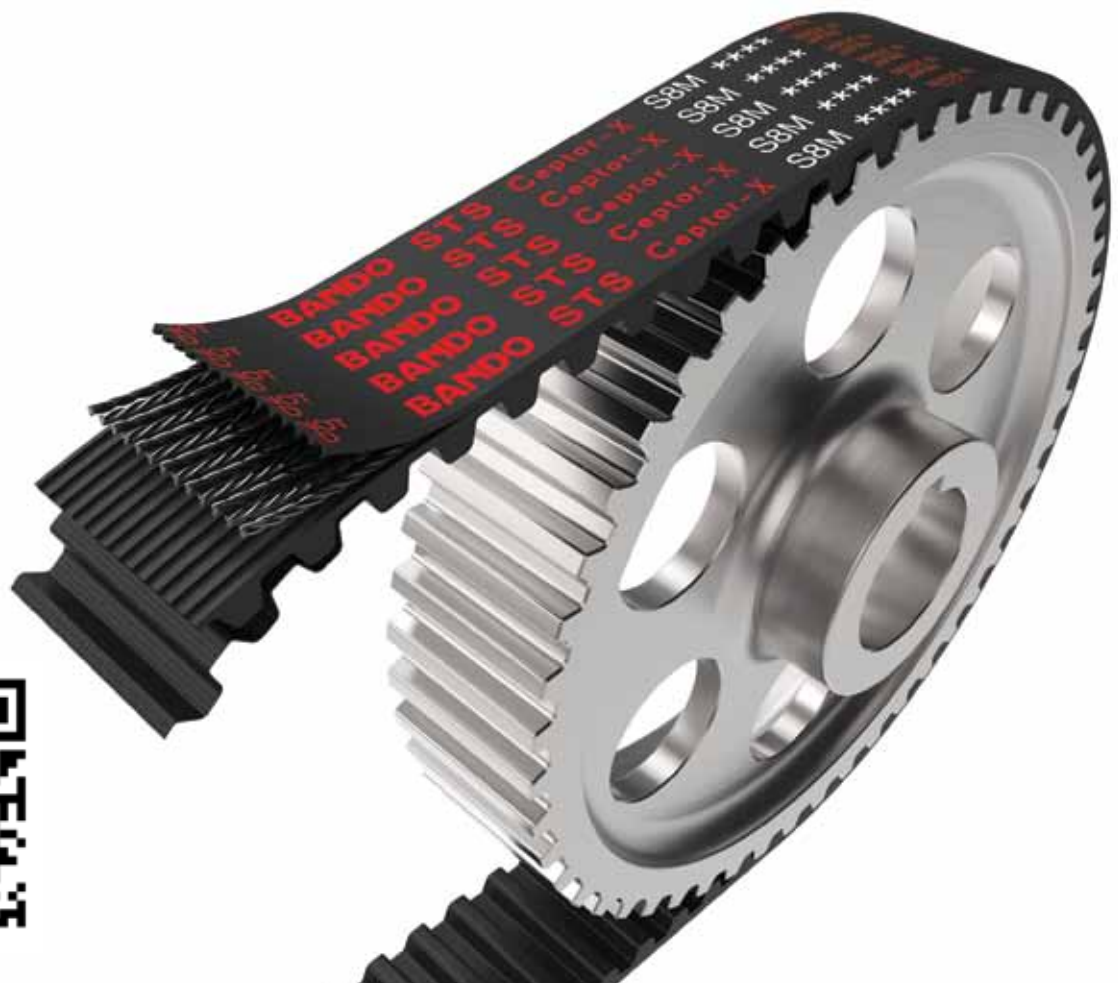

Ceptor®-X STS

Super torque synchronous belt  
available for high load

Ceptor®-X STS



Product brochure  
as PDF-File:



# FEATURES

High power ratio compared with current product.

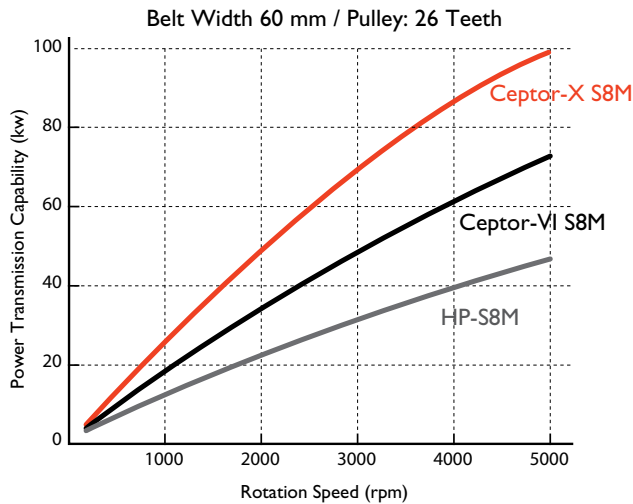

Reduced Belt Width with Ceptor-X

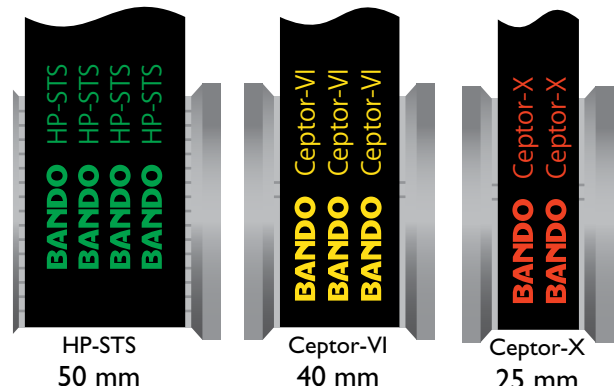

The improved design of Ceptor-X allows reduced belt and pulley widths.

# BELT STRUCTURE

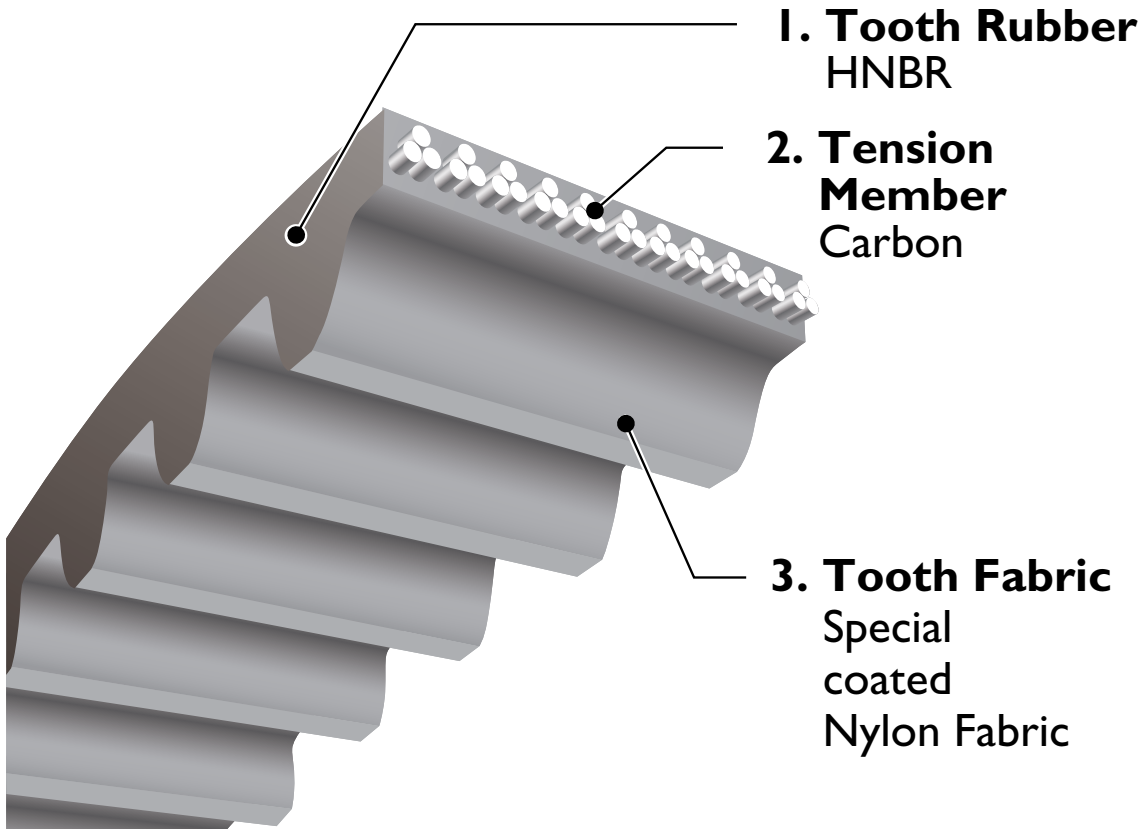

# PERFORMANCE

## Ceptor<sup>®</sup>-X advantages:

- (1) Excellent Tension Stability
- (2) High Reliability

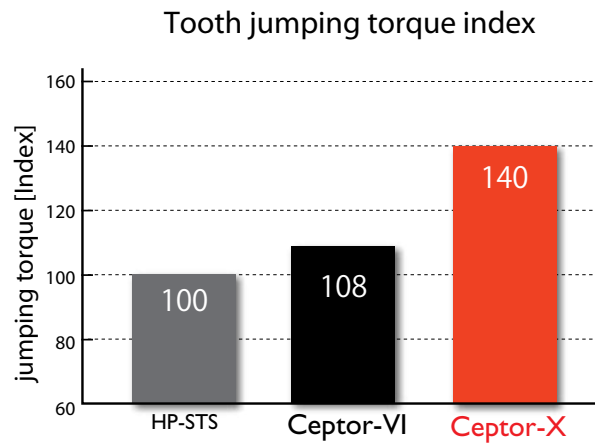
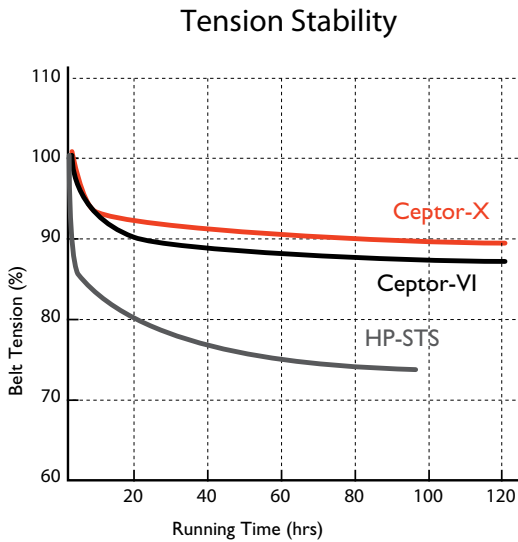

- (3) Noise Reduction
- (4) Long Life Time

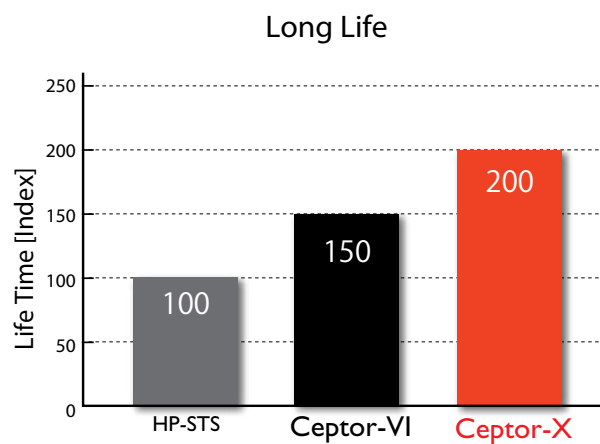
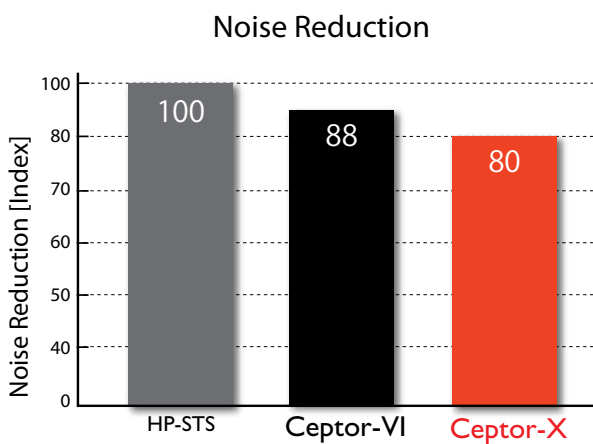

Ceptor<sup>®</sup>-X is suitable for Standard Pulleys.

# PRODUCT LINE-UP

## Ceptor-X S3M

Description	Pitch Length (mm)	No. of Teeth
Ceptor-X S3M 93	93	31
Ceptor-X S3M 120	120	40
Ceptor-X S3M 123	123	41
Ceptor-X S3M 129	129	43
Ceptor-X S3M 132	132	44
Ceptor-X S3M 141	141	47
Ceptor-X S3M 144	144	48
Ceptor-X S3M 147	147	49
Ceptor-X S3M 150	150	50
Ceptor-X S3M 156	156	52
Ceptor-X S3M 159	159	53
Ceptor-X S3M 162	162	54
Ceptor-X S3M 168	168	56
Ceptor-X S3M 171	171	57
Ceptor-X S3M 174	174	58
Ceptor-X S3M 177	177	59
Ceptor-X S3M 180	180	60
Ceptor-X S3M 183	183	61
Ceptor-X S3M 186	186	62
Ceptor-X S3M 189	189	63
Ceptor-X S3M 192	192	64
Ceptor-X S3M 195	195	65
Ceptor-X S3M 198	198	66
Ceptor-X S3M 201	201	67
Ceptor-X S3M 204	204	68
Ceptor-X S3M 207	207	69
Ceptor-X S3M 210	210	70
Ceptor-X S3M 213	213	71
Ceptor-X S3M 219	219	73
Ceptor-X S3M 222	222	74
Ceptor-X S3M 225	225	75
Ceptor-X S3M 228	228	76
Ceptor-X S3M 234	234	78
Ceptor-X S3M 237	237	79
Ceptor-X S3M 240	240	80
Ceptor-X S3M 243	243	81
Ceptor-X S3M 246	246	82
Ceptor-X S3M 249	249	83
Ceptor-X S3M 252	252	84
Ceptor-X S3M 255	255	85
Ceptor-X S3M 258	258	86
Ceptor-X S3M 264	264	88
Ceptor-X S3M 267	267	89
Ceptor-X S3M 270	270	90
Ceptor-X S3M 273	273	91
Ceptor-X S3M 276	276	92
Ceptor-X S3M 279	279	93
Ceptor-X S3M 282	282	94
Ceptor-X S3M 285	285	95
Ceptor-X S3M 288	288	96
Ceptor-X S3M 291	291	97
Ceptor-X S3M 294	294	98
Ceptor-X S3M 297	297	99
Ceptor-X S3M 300	300	100
Ceptor-X S3M 303	303	101
Ceptor-X S3M 306	306	102
Ceptor-X S3M 309	309	103
Ceptor-X S3M 312	312	104
Ceptor-X S3M 315	315	105
Ceptor-X S3M 318	318	106
Ceptor-X S3M 324	324	108
Ceptor-X S3M 327	327	109

## Ceptor-X S3M

Description	Pitch Length (mm)	No. of Teeth
Ceptor-X S3M 330	330	110
Ceptor-X S3M 333	333	111
Ceptor-X S3M 336	336	112
Ceptor-X S3M 339	339	113
Ceptor-X S3M 342	342	114
Ceptor-X S3M 351	351	117
Ceptor-X S3M 354	354	118
Ceptor-X S3M 360	360	120
Ceptor-X S3M 363	363	121
Ceptor-X S3M 366	366	122
Ceptor-X S3M 369	369	123
Ceptor-X S3M 372	372	124
Ceptor-X S3M 375	375	125
Ceptor-X S3M 378	378	126
Ceptor-X S3M 384	384	128
Ceptor-X S3M 387	387	129
Ceptor-X S3M 390	390	130
Ceptor-X S3M 396	396	132
Ceptor-X S3M 399	399	133
Ceptor-X S3M 402	402	134
Ceptor-X S3M 405	405	135
Ceptor-X S3M 408	408	136
Ceptor-X S3M 417	417	139
Ceptor-X S3M 420	420	140
Ceptor-X S3M 423	423	141
Ceptor-X S3M 426	426	142
Ceptor-X S3M 432	432	144
Ceptor-X S3M 438	438	146
Ceptor-X S3M 444	444	148
Ceptor-X S3M 447	447	149
Ceptor-X S3M 453	453	151
Ceptor-X S3M 456	456	152
Ceptor-X S3M 459	459	153
Ceptor-X S3M 468	468	156
Ceptor-X S3M 471	471	157
Ceptor-X S3M 474	474	158
Ceptor-X S3M 480	480	160
Ceptor-X S3M 486	486	162
Ceptor-X S3M 489	489	163
Ceptor-X S3M 492	492	164
Ceptor-X S3M 498	498	166
Ceptor-X S3M 501	501	167
Ceptor-X S3M 507	507	169
Ceptor-X S3M 513	513	171
Ceptor-X S3M 516	516	172
Ceptor-X S3M 519	519	173
Ceptor-X S3M 522	522	174
Ceptor-X S3M 525	525	175
Ceptor-X S3M 534	534	178
Ceptor-X S3M 537	537	179
Ceptor-X S3M 540	540	180
Ceptor-X S3M 549	549	183
Ceptor-X S3M 552	552	184
Ceptor-X S3M 555	555	185
Ceptor-X S3M 564	564	188
Ceptor-X S3M 573	573	191
Ceptor-X S3M 579	579	193
Ceptor-X S3M 588	588	196

# PRODUCT LINE-UP

## Ceptor-X S3M

Description	Pitch Length (mm)	No. of Teeth
Ceptor-X S3M 597	597	199
Ceptor-X S3M 600	600	200
Ceptor-X S3M 609	609	203
Ceptor-X S3M 621	621	207
Ceptor-X S3M 633	633	211
Ceptor-X S3M 636	636	212
Ceptor-X S3M 648	648	216
Ceptor-X S3M 657	657	219
Ceptor-X S3M 660	660	220
Ceptor-X S3M 666	666	222
Ceptor-X S3M 681	681	227
Ceptor-X S3M 690	690	230
Ceptor-X S3M 699	699	233
Ceptor-X S3M 720	720	240
Ceptor-X S3M 726	726	242
Ceptor-X S3M 735	735	245
Ceptor-X S3M 741	741	247
Ceptor-X S3M 750	750	250
Ceptor-X S3M 768	768	256
Ceptor-X S3M 771	771	257
Ceptor-X S3M 789	789	263
Ceptor-X S3M 804	804	268
Ceptor-X S3M 810	810	270
Ceptor-X S3M 825	825	275
Ceptor-X S3M 852	852	284
Ceptor-X S3M 858	858	286
Ceptor-X S3M 882	882	294
Ceptor-X S3M 885	885	295
Ceptor-X S3M 888	888	296
Ceptor-X S3M 900	900	300
Ceptor-X S3M 909	909	303
Ceptor-X S3M 918	918	306
Ceptor-X S3M 927	927	309
Ceptor-X S3M 936	936	312
Ceptor-X S3M 954	954	318
Ceptor-X S3M 990	990	330
Ceptor-X S3M 999	999	333
Ceptor-X S3M 1014	1.014	338
Ceptor-X S3M 1050	1.050	350
Ceptor-X S3M 1080	1.080	360
Ceptor-X S3M 1119	1.119	373
Ceptor-X S3M 1134	1.134	378
Ceptor-X S3M 1146	1.146	382
Ceptor-X S3M 1170	1.170	390
Ceptor-X S3M 1176	1.176	392
Ceptor-X S3M 1188	1.188	396
Ceptor-X S3M 1203	1.203	401
Ceptor-X S3M 1221	1.221	407
Ceptor-X S3M 1236	1.236	412
Ceptor-X S3M 1245	1.245	415
Ceptor-X S3M 1290	1.290	430
Ceptor-X S3M 1299	1.299	433
Ceptor-X S3M 1332	1.332	444
Ceptor-X S3M 1401	1.401	467
Ceptor-X S3M 1419	1.419	473
Ceptor-X S3M 1530	1.530	510
Ceptor-X S3M 1680	1.680	560
Ceptor-X S3M 1788	1.788	596

## Ceptor-X S5M

Description	Pitch Length (mm)	No. of Teeth
Ceptor-X S5M 225	225	45
Ceptor-X S5M 230	230	46
Ceptor-X S5M 255	255	51
Ceptor-X S5M 260	260	52
Ceptor-X S5M 275	275	55
Ceptor-X S5M 285	285	57
Ceptor-X S5M 295	295	59
Ceptor-X S5M 300	300	60
Ceptor-X S5M 305	305	61
Ceptor-X S5M 320	320	64
Ceptor-X S5M 325	325	65
Ceptor-X S5M 340	340	68
Ceptor-X S5M 350	350	70
Ceptor-X S5M 360	360	72
Ceptor-X S5M 370	370	74
Ceptor-X S5M 375	375	75
Ceptor-X S5M 380	380	76
Ceptor-X S5M 390	390	78
Ceptor-X S5M 400	400	80
Ceptor-X S5M 410	410	82
Ceptor-X S5M 415	415	83
Ceptor-X S5M 420	420	84
Ceptor-X S5M 425	425	85
Ceptor-X S5M 435	435	87
Ceptor-X S5M 440	440	88
Ceptor-X S5M 445	445	89
Ceptor-X S5M 450	450	90
Ceptor-X S5M 475	475	95
Ceptor-X S5M 490	490	98
Ceptor-X S5M 500	500	100
Ceptor-X S5M 520	520	104
Ceptor-X S5M 525	525	105
Ceptor-X S5M 530	530	106
Ceptor-X S5M 545	545	109
Ceptor-X S5M 550	550	110
Ceptor-X S5M 560	560	112

# PRODUCT LINE-UP

## Ceptor-X S5M

Description	Pitch Length (mm)	No. of Teeth
Ceptor-X S5M 565	565	113
Ceptor-X S5M 570	570	114
Ceptor-X S5M 575	575	115
Ceptor-X S5M 590	590	118
Ceptor-X S5M 595	595	119
Ceptor-X S5M 600	600	120
Ceptor-X S5M 625	625	125
Ceptor-X S5M 635	635	127
Ceptor-X S5M 640	640	128
Ceptor-X S5M 645	645	129
Ceptor-X S5M 650	650	130
Ceptor-X S5M 665	665	133
Ceptor-X S5M 670	670	134
Ceptor-X S5M 675	675	135
Ceptor-X S5M 690	690	138
Ceptor-X S5M 695	695	139
Ceptor-X S5M 700	700	140
Ceptor-X S5M 710	710	142
Ceptor-X S5M 720	720	144
Ceptor-X S5M 725	725	145
Ceptor-X S5M 740	740	148
Ceptor-X S5M 750	750	150
Ceptor-X S5M 765	765	153
Ceptor-X S5M 770	770	154
Ceptor-X S5M 775	775	155
Ceptor-X S5M 780	780	156
Ceptor-X S5M 800	800	160
Ceptor-X S5M 810	810	162
Ceptor-X S5M 830	830	166
Ceptor-X S5M 845	845	169
Ceptor-X S5M 850	850	170
Ceptor-X S5M 860	860	172
Ceptor-X S5M 870	870	174
Ceptor-X S5M 890	890	178
Ceptor-X S5M 900	900	180
Ceptor-X S5M 920	920	184
Ceptor-X S5M 930	930	186

## Ceptor-X S5M

Description	Pitch Length (mm)	No. of Teeth
Ceptor-X S5M 940	940	188
Ceptor-X S5M 950	950	190
Ceptor-X S5M 965	965	193
Ceptor-X S5M 975	975	195
Ceptor-X S5M 1000	1.000	200
Ceptor-X S5M 1025	1.025	205
Ceptor-X S5M 1050	1.050	210
Ceptor-X S5M 1055	1.055	211
Ceptor-X S5M 1085	1.085	217
Ceptor-X S5M 1090	1.090	218
Ceptor-X S5M 1100	1.100	220
Ceptor-X S5M 1105	1.105	221
Ceptor-X S5M 1115	1.115	223
Ceptor-X S5M 1120	1.120	224
Ceptor-X S5M 1125	1.125	225
Ceptor-X S5M 1135	1.135	227
Ceptor-X S5M 1145	1.145	229
Ceptor-X S5M 1160	1.160	232
Ceptor-X S5M 1165	1.165	233
Ceptor-X S5M 1195	1.195	239
Ceptor-X S5M 1225	1.225	245
Ceptor-X S5M 1250	1.250	250
Ceptor-X S5M 1260	1.260	252
Ceptor-X S5M 1270	1.270	254
Ceptor-X S5M 1295	1.295	259
Ceptor-X S5M 1350	1.350	270
Ceptor-X S5M 1420	1.420	284
Ceptor-X S5M 1500	1.500	300
Ceptor-X S5M 1505	1.505	301
Ceptor-X S5M 1530	1.530	306
Ceptor-X S5M 1595	1.595	319
Ceptor-X S5M 1605	1.605	321
Ceptor-X S5M 1680	1.680	336
Ceptor-X S5M 1715	1.715	343
Ceptor-X S5M 1800	1.800	360
Ceptor-X S5M 2000	2.000	400

# PRODUCT LINE-UP

## Ceptor-X S8M

Description	Pitch Length (mm)	No. of Teeth
Ceptor-X S8M 480	480.00	60
Ceptor-X S8M 496	496.00	62
Ceptor-X S8M 512	512.00	64
Ceptor-X S8M 520	520.00	65
Ceptor-X S8M 528	528.00	66
Ceptor-X S8M 560	560.00	70
Ceptor-X S8M 584	584.00	73
Ceptor-X S8M 600	600.00	75
Ceptor-X S8M 632	632.00	79
Ceptor-X S8M 640	640.00	80
Ceptor-X S8M 656	656.00	82
Ceptor-X S8M 672	672.00	84
Ceptor-X S8M 680	680.00	85
Ceptor-X S8M 712	712.00	89
Ceptor-X S8M 720	720.00	90
Ceptor-X S8M 728	728.00	91
Ceptor-X S8M 760	760.00	95
Ceptor-X S8M 800	800.00	100
Ceptor-X S8M 824	824.00	103
Ceptor-X S8M 840	840.00	105
Ceptor-X S8M 848	848.00	106
Ceptor-X S8M 880	880.00	110
Ceptor-X S8M 888	888.00	111
Ceptor-X S8M 896	896.00	112
Ceptor-X S8M 920	920.00	115
Ceptor-X S8M 944	944.00	118
Ceptor-X S8M 960	960.00	120
Ceptor-X S8M 976	976.00	122
Ceptor-X S8M 984	984.00	123
Ceptor-X S8M 1000	1000.00	125
Ceptor-X S8M 1032	1032.00	129
Ceptor-X S8M 1040	1040.00	130
Ceptor-X S8M 1056	1056.00	132
Ceptor-X S8M 1080	1080.00	135
Ceptor-X S8M 1096	1096.00	137
Ceptor-X S8M 1120	1120.00	140
Ceptor-X S8M 1136	1136.00	142
Ceptor-X S8M 1152	1152.00	144
Ceptor-X S8M 1160	1160.00	145
Ceptor-X S8M 1184	1184.00	148
Ceptor-X S8M 1192	1192.00	149
Ceptor-X S8M 1200	1200.00	150
Ceptor-X S8M 1216	1216.00	152
Ceptor-X S8M 1224	1224.00	153
Ceptor-X S8M 1240	1240.00	155
Ceptor-X S8M 1248	1248.00	156
Ceptor-X S8M 1272	1272.00	159
Ceptor-X S8M 1280	1280.00	160
Ceptor-X S8M 1296	1296.00	162
Ceptor-X S8M 1312	1312.00	164

## Ceptor-X S8M

Description	Pitch Length (mm)	No. of Teeth
Ceptor-X S8M 1344	1344.00	168
Ceptor-X S8M 1352	1352.00	169
Ceptor-X S8M 1360	1360.00	170
Ceptor-X S8M 1384	1384.00	173
Ceptor-X S8M 1392	1392.00	174
Ceptor-X S8M 1400	1400.00	175
Ceptor-X S8M 1424	1424.00	178
Ceptor-X S8M 1440	1440.00	180
Ceptor-X S8M 1480	1480.00	185
Ceptor-X S8M 1520	1520.00	190
Ceptor-X S8M 1552	1552.00	194
Ceptor-X S8M 1600	1600.00	200
Ceptor-X S8M 1648	1648.00	206
Ceptor-X S8M 1680	1680.00	210
Ceptor-X S8M 1728	1728.00	216
Ceptor-X S8M 1760	1760.00	220
Ceptor-X S8M 1776	1776.00	222
Ceptor-X S8M 1800	1800.00	225
Ceptor-X S8M 1808	1808.00	226
Ceptor-X S8M 1856	1856.00	232
Ceptor-X S8M 1880	1880.00	235
Ceptor-X S8M 1912	1912.00	239
Ceptor-X S8M 1952	1952.00	244
Ceptor-X S8M 2000	2000.00	250
Ceptor-X S8M 2040	2040.00	255
Ceptor-X S8M 2120	2120.00	265
Ceptor-X S8M 2160	2160.00	270
Ceptor-X S8M 2240	2240.00	280
Ceptor-X S8M 2304	2304.00	288
Ceptor-X S8M 2400	2400.00	300
Ceptor-X S8M 2496	2496.00	312
Ceptor-X S8M 2560	2560.00	320
Ceptor-X S8M 2600	2600.00	325
Ceptor-X S8M 2800	2800.00	350
Ceptor-X S8M 2880	2880.00	360
Ceptor-X S8M 2944	2944.00	368
Ceptor-X S8M 3200	3200.00	400
Ceptor-X S8M 3600	3600.00	450
Ceptor-X S8M 3720	3720.00	465
Ceptor-X S8M 3904	3904.00	488
Ceptor-X S8M 4400	4400.00	550

## Ceptor-X S14M

Description	Pitch Length (mm)	No. of Teeth
Ceptor-X S14M1008	1008.00	72
Ceptor-X S14M1120	1120.00	80
Ceptor-X S14M1190	1190.00	85
Ceptor-X S14M1246	1246.00	89
Ceptor-X S14M1400	1400.00	100
Ceptor-X S14M1540	1540.00	110
Ceptor-X S14M1610	1610.00	115
Ceptor-X S14M1652	1652.00	118
Ceptor-X S14M1778	1778.00	127
Ceptor-X S14M1806	1806.00	129
Ceptor-X S14M1890	1890.00	135
Ceptor-X S14M1904	1904.00	136
Ceptor-X S14M1960	1960.00	140
Ceptor-X S14M2002	2002.00	143
Ceptor-X S14M2100	2100.00	150
Ceptor-X S14M2240	2240.00	160
Ceptor-X S14M2310	2310.00	165
Ceptor-X S14M2380	2380.00	170
Ceptor-X S14M2450	2450.00	175
Ceptor-X S14M2506	2506.00	179
Ceptor-X S14M2590	2590.00	185
Ceptor-X S14M2660	2660.00	190
Ceptor-X S14M2800	2800.00	200
Ceptor-X S14M3150	3150.00	225
Ceptor-X S14M3248	3248.00	232

## Ceptor-X S14M

Description	Pitch Length (mm)	No. of Teeth
Ceptor-X S14M3500	3500.00	250
Ceptor-X S14M3556	3556.00	254
Ceptor-X S14M3850	3850.00	275
Ceptor-X S14M4004	4004.00	286
Ceptor-X S14M4060	4060.00	290
Ceptor-X S14M4326	4326.00	309
Ceptor-X S14M4508	4508.00	322
Ceptor-X S14M5012	5012.00	358

\* Please note that this catalogue is reserved to changes. All data in this publication have been compiled and checked with utmost diligence, nevertheless errors and mistakes cannot be totally excluded. Do not duplicate or copy any part or contents without the permission of Bando Europe GmbH.